

Article number: 07110055001

Description: Universal joint single 0.110.055.001
S=117 X= Bore with keyway

Measures

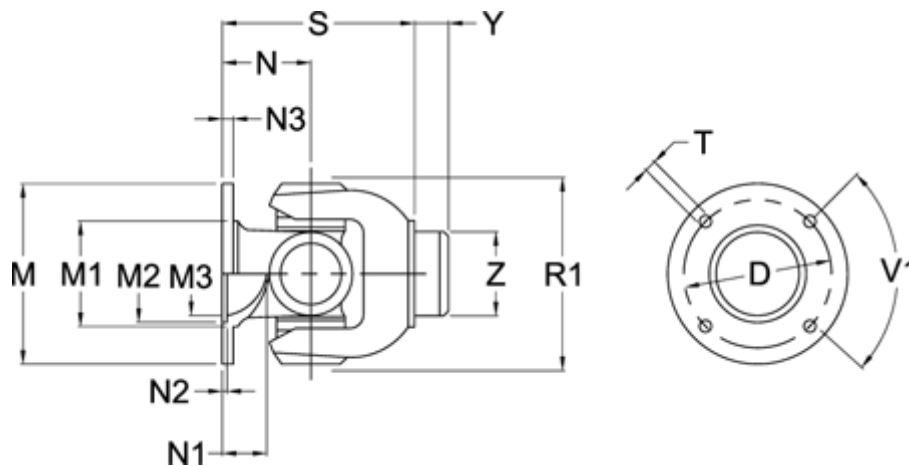

D	= 84 \pm 0,1	N2	= 2,5 \pm 0,5	Z = 44.25
Flange diameter M	= 100	N3	= 7	
M1	= 66	Number of Flangeholes	= 6	
M2	= 57	R1	= 98	
M3	= 56	S min	= 117	
Max. Bending Angle degrees	= 35	T	= 8 B12	
N	= 58	V1 degrees	= 60	
N1	= 23	Y	= 15	